





more strength



wider range with fewer pieces



orthogonal joint



lower cost



higher IP rating



new unique design



lower transport costs



excellent painting



lower stock volume

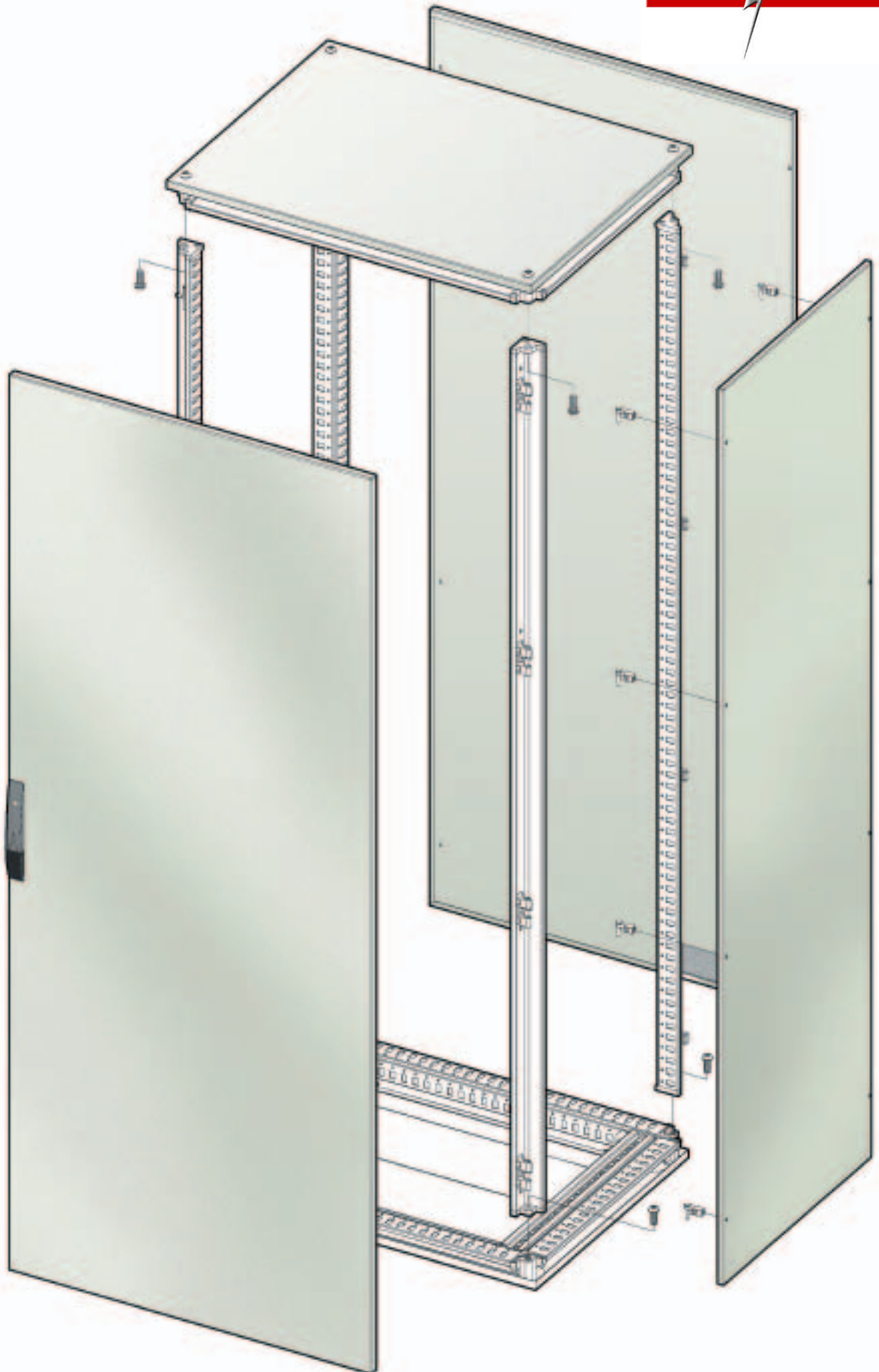

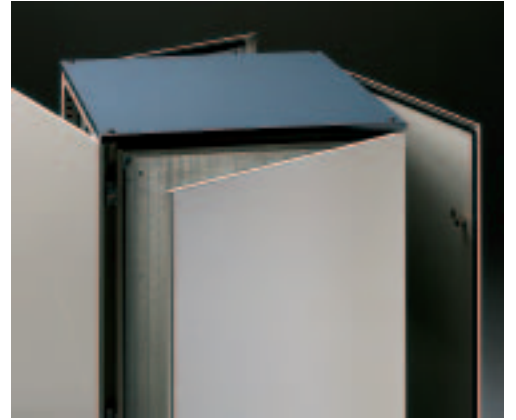

technology
and innovation



modularity
and
versatile
solutions







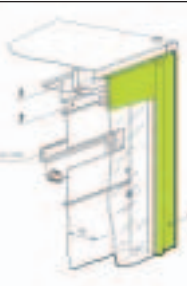

a trend
design

ASSEMBLED CABINET

						
dimensions W x H x D	cabinet with front blank door and rear panel (1)	cabinet with front glazed door and rear panel (2)	cabinet with front and rear blank door (3)	cabinet frame for modular systems	modular structure	glazed door
200x1800x500						
200x2000x600						
300x1600x400						
300x1600x500						
300x1600x600						
300x1800x400						
300x1800x500						
300x1800x600						
300x1800x800						
300x2000x400						
300x2000x500						
300x2000x600						
300x2000x800						
300x2200x500						
300x2200x600						
300x2200x800						
400x1600x400	CE1000-041604PR		CE1000-041604DP			
400x1600x500	CE1000-041605PR		CE1000-041605DP			
400x1600x600	CE1000-041606PR		CE1000-041606DP			
400x1800x400	CE1000-041804PR		CE1000-041804DP			
400x1800x500	CE1000-041805PR		CE1000-041805DP			
400x1800x600	CE1000-041806PR		CE1000-041806DP			
400x1800x800	CE1000-041808PR		CE1000-041808DP			
400x2000x400	CE1000-042004PR		CE1000-042004DP			
400x2000x500	CE1000-042005PR		CE1000-042005DP			
400x2000x600	CE1000-042006PR		CE1000-042006DP			
400x2000x800	CE1000-042008PR		CE1000-042008DP			
400x2200x500	CE1000-042205PR		CE1000-042205DP			
400x2200x600	CE1000-042206PR		CE1000-042206DP			
400x2200x800	CE1000-042208PR		CE1000-042208DP			
600x1400x400	CE1000-061404PR	CE1000-061404PX	CE1000-061404DP			
600x1400x500	CE1000-061405PR	CE1000-061405PX	CE1000-061405DP			
600x1600x400	CE1000-061604PR	CE1000-061604PX	CE1000-061604DP			
600x1600x500	CE1000-061605PR	CE1000-061605PX	CE1000-061605DP			
600x1600x600	CE1000-061606PR	CE1000-061606PX	CE1000-061606DP			
600x1800x400	CE1000-061804PR	CE1000-061804PX	CE1000-061804DP	CE1000-061804ST	ATSM-060180	ATPX-060180S
600x1800x500	CE1000-061805PR	CE1000-061805PX	CE1000-061805DP	CE1000-061805ST	ATSM-060180	ATPX-060180S
600x1800x600	CE1000-061806PR	CE1000-061806PX	CE1000-061806DP	CE1000-061806ST	ATSM-060180	ATPX-060180S





(1) supply includes the cabinet frame, blank door and rear panel. To be ordered separately mounting plate, side panels, plinth and eyebolts WTGS-001 (page 10-11)
 (2) supply includes the cabinet frame, glazed door and rear panel. To be ordered separately mounting plate, side panels, plinth and eyebolts WTGS-001 (page 10-11)
 (3) supply includes the cabinet frame, front door and rear door. To be ordered separately mounting plate, side panels, plinth and eyebolts WTGS-001 (page 10-11)

ASSEMBLED CABINET

						
dimensions W x H x D	cabinet with front blank door and rear panel (1)	cabinet with front glazed door and rear panel (2)	cabinet with front and rear blank door (3)	cabinet frame for modular systems	modular structure	glazed door
600x1800x800	CE1000-061808PR	CE1000-061808PX	CE1000-061808DP	CE1000-061808ST	ATSM-060180	ATPX-060180S
600x2000x400	CE1000-062004PR	CE1000-062004PX	CE1000-062004DP	CE1000-062004ST	ATSM-060200	ATPX-060200S
600x2000x500	CE1000-062005PR	CE1000-062005PX	CE1000-062005DP	CE1000-062005ST	ATSM-060200	ATPX-060200S
600x2000x600	CE1000-062006PR	CE1000-062006PX	CE1000-062006DP	CE1000-062006ST	ATSM-060200	ATPX-060200S
600x2000x800	CE1000-062008PR	CE1000-062008PX	CE1000-062008DP	CE1000-062008ST	ATSM-060200	ATPX-060200S
600x2000x1000	CE1000-062010PR					
600x2200x500	CE1000-062205PR	CE1000-062205PX	CE1000-062205DP			
600x2200x600	CE1000-062206PR	CE1000-062206PX	CE1000-062206DP			
600x2200x800	CE1000-062208PR	CE1000-062208PX	CE1000-062208DP			
800x1400x400	CE1000-081404PR	CE1000-081404PX	CE1000-081404DP			
800x1400x500	CE1000-081405PR	CE1000-081405PX	CE1000-081405DP			
800x1600x400	CE1000-081604PR	CE1000-081604PX	CE1000-081604DP			
800x1600x500	CE1000-081605PR	CE1000-081605PX	CE1000-081605DP			
800x1600x600	CE1000-081606PR	CE1000-081606PX	CE1000-081606DP			
800x1800x400	CE1000-081804PR	CE1000-081804PX	CE1000-081804DP	CE1000-081804ST	ATSM-080180	ATPX-080180S
800x1800x500	CE1000-081805PR	CE1000-081805PX	CE1000-081805DP	CE1000-081805ST	ATSM-080180	ATPX-080180S
800x1800x600	CE1000-081806PR	CE1000-081806PX	CE1000-081806DP	CE1000-081806ST	ATSM-080180	ATPX-080180S
800x1800x800	CE1000-081808PR	CE1000-081808PX	CE1000-081808DP	CE1000-081808ST	ATSM-080180	ATPX-080180S
800x2000x400	CE1000-082004PR	CE1000-082004PX	CE1000-082004DP	CE1000-082004ST	ATSM-080200	ATPX-080200S
800x2000x500	CE1000-082005PR	CE1000-082005PX	CE1000-082005DP	CE1000-082005ST	ATSM-080200	ATPX-080200S
800x2000x600	CE1000-082006PR	CE1000-082006PX	CE1000-082006DP	CE1000-082006ST	ATSM-080200	ATPX-080200S
800x2000x800	CE1000-082008PR	CE1000-082008PX	CE1000-082008DP	CE1000-082008ST	ATSM-080200	ATPX-080200S
800x2000x1000	CE1000-082010PR					
800x2200x500	CE1000-082205PR	CE1000-082205PX	CE1000-082205DP			
800x2200x600	CE1000-082206PR	CE1000-082206PX	CE1000-082206DP			
800x2200x800	CE1000-082208PR	CE1000-082208PX	CE1000-082208DP			
1000x1600x400	CE1000-101604PR	CE1000-101604PX	CE1000-101604DP			
1000x1600x500	CE1000-101605PR	CE1000-101605PX	CE1000-101605DP			
1000x1600x600	CE1000-101606PR	CE1000-101606PX	CE1000-101606DP			
1000x1800x400	CE1000-101804PR	CE1000-101804PX	CE1000-101804DP			
1000x1800x500	CE1000-101805PR	CE1000-101805PX	CE1000-101805DP			
1000x1800x600	CE1000-101806PR	CE1000-101806PX	CE1000-101806DP			
1000x1800x800	CE1000-101808PR	CE1000-101808PX	CE1000-101808DP			
1000x2000x400	CE1000-102004PR	CE1000-102004PX	CE1000-102004DP			
1000x2000x500	CE1000-102005PR	CE1000-102005PX	CE1000-102005DP			
1000x2000x600	CE1000-102006PR	CE1000-102006PX	CE1000-102006DP			
1000x2000x800	CE1000-102008PR	CE1000-102008PX	CE1000-102008DP			
1000x2200x500	CE1000-102205PR	CE1000-102205PX	CE1000-102205DP			

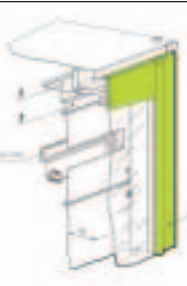

(1) supply includes the cabinet frame, blank door and rear panel. To be ordered separately mounting plate, side panels, plinth and eyebolts WTGS-001 (page 12-13)
 (2) supply includes the cabinet frame, glazed door and rear panel. To be ordered separately mounting plate, side panels, plinth and eyebolts WTGS-001 (page 12-13)
 (3) supply includes the cabinet frame, front door and rear door. To be ordered separately mounting plate, side panels, plinth and eyebolts WTGS-001 (page 12-13)

ASSEMBLED CABINET

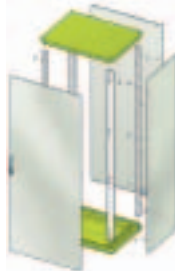
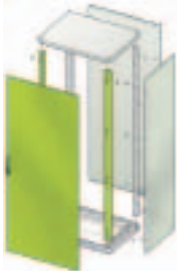

						
dimensions W x H x D	cabinet with front blank door and rear panel (1)	cabinet with front glazed door and rear panel (2)	cabinet with front and rear blank door (3)	cabinet frame for modular systems	modular structure	glazed door
1000x2200x600	CE1000-102206PR	CE1000-102206PX	CE1000-102206DP			
1000x2200x800	CE1000-102208PR	CE1000-102208PX	CE1000-102208DP			
1200x1400x400	CE1000-121404PR		CE1000-121404DP			
1200x1400x500	CE1000-121405PR		CE1000-121405DP			
1200x1600x400	CE1000-121604PR		CE1000-121604DP			
1200x1600x500	CE1000-121605PR		CE1000-121605DP			
1200x1600x600	CE1000-121606PR		CE1000-121606DP			
1200x1800x400	CE1000-121804PR		CE1000-121804DP			
1200x1800x500	CE1000-121805PR		CE1000-121805DP			
1200x1800x600	CE1000-121806PR		CE1000-121806DP			
1200x1800x800	CE1000-121808PR		CE1000-121808DP			
1200x2000x400	CE1000-122004PR		CE1000-122004DP			
1200x2000x500	CE1000-122005PR		CE1000-122005DP			
1200x2000x600	CE1000-122006PR		CE1000-122006DP			
1200x2000x800	CE1000-122008PR		CE1000-122008DP			
1200x2000x1000	CE1000-122010PR					
1200x2200x500	CE1000-122205PR		CE1000-122205DP			
1200x2200x600	CE1000-122206PR		CE1000-122206DP			
1200x2200x800	CE1000-122208PR		CE1000-122208DP			
1400x2000x400	CE1000-142004PR		CE1000-142004DP			
1400x2000x500	CE1000-142005PR		CE1000-142005DP			
1400x2000x600	CE1000-142006PR		CE1000-142006DP			
1400x2000x800	CE1000-142008PR		CE1000-142008DP			
1600x1400x400	CE1000-161404PR		CE1000-161404DP			
1600x1400x500	CE1000-161405PR		CE1000-161405DP			
1600x2000x400	CE1000-162004PR		CE1000-162004DP			
1600x2000x500	CE1000-162005PR		CE1000-162005DP			
1600x2000x600	CE1000-162006PR		CE1000-162006DP			
1600x2000x800	CE1000-162008PR		CE1000-162008DP			

(1) supply includes the cabinet frame, blank door and rear panel. To be ordered separately mounting plate, side panels, plinth and eyebolts WTGS-001 (page 14-15)
 (2) supply includes the cabinet frame, glazed door and rear panel. To be ordered separately mounting plate, side panels, plinth and eyebolts WTGS-001 (page 14-15)
 (3) supply includes the cabinet frame, front door and rear door. To be ordered separately mounting plate, side panels, plinth and eyebolts WTGS-001 (page 14-15)

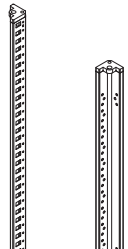
FLAT-PACK CABINET

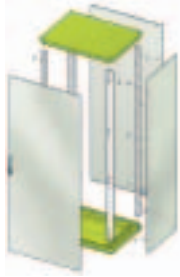
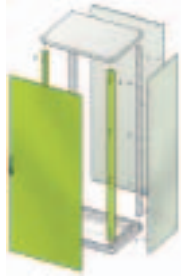

					
dimensions W x H x D	top and bottom	blank door with front uprights	rear panel with rear uprights	glazed door with front uprights	pair of front uprights for multiple doors cabinet
200x1800x500					
200x2000x600					
300x1600x400	ATTF-030040	ATPO-030160	ATRE-030160		
300x1600x500	ATTF-030050	ATPO-030160	ATRE-030160		
300x1600x600	ATTF-030060	ATPO-030160	ATRE-030160		
300x1800x400	ATTF-030040	ATPO-030180	ATRE-030180		
300x1800x500	ATTF-030050	ATPO-030180	ATRE-030180		
300x1800x600	ATTF-030060	ATPO-030180	ATRE-030180		
300x1800x800	ATTF-030080	ATPO-030180	ATRE-030180		
300x2000x400	ATTF-030040	ATPO-030200	ATRE-030200		
300x2000x500	ATTF-030050	ATPO-030200	ATRE-030200		
300x2000x600	ATTF-030060	ATPO-030200	ATRE-030200		
300x2000x800	ATTF-030080	ATPO-030200	ATRE-030200		
300x2200x500	ATTF-030050	ATPO-030220	ATRE-030220		
300x2200x600	ATTF-030060	ATPO-030220	ATRE-030220		
300x2200x800	ATTF-030080	ATPO-030220	ATRE-030220		
400x1600x400	ATTF-040040	ATPO-040160	ATRE-040160		
400x1600x500	ATTF-040050	ATPO-040160	ATRE-040160		
400x1600x600	ATTF-040060	ATPO-040160	ATRE-040160		
400x1800x400	ATTF-040040	ATPO-040180	ATRE-040180		
400x1800x500	ATTF-040050	ATPO-040180	ATRE-040180		
400x1800x600	ATTF-040060	ATPO-040180	ATRE-040180		
400x1800x800	ATTF-040080	ATPO-040180	ATRE-040180		
400x2000x400	ATTF-040040	ATPO-040200	ATRE-040200		
400x2000x500	ATTF-040050	ATPO-040200	ATRE-040200		
400x2000x600	ATTF-040060	ATPO-040200	ATRE-040200		
400x2000x800	ATTF-040080	ATPO-040200	ATRE-040200		
400x2200x500	ATTF-040050	ATPO-040220	ATRE-040220		
400x2200x600	ATTF-040060	ATPO-040220	ATRE-040220		
400x2200x800	ATTF-040080	ATPO-040220	ATRE-040220		
600x1400x400	ATTF-060040	ATPO-060140	ATRE-060140	ATPX-060140	
600x1400x500	ATTF-060050	ATPO-060140	ATRE-060140	ATPX-060140	
600x1600x400	ATTF-060040	ATPO-060160	ATRE-060160	ATPX-060160	
600x1600x500	ATTF-060050	ATPO-060160	ATRE-060160	ATPX-060160	
600x1600x600	ATTF-060060	ATPO-060160	ATRE-060160	ATPX-060160	
600x1800x400	ATTF-060040	ATPO-060180	ATRE-060180	ATPX-060180	ATMF-001800
600x1800x500	ATTF-060050	ATPO-060180	ATRE-060180	ATPX-060180	ATMF-001800
600x1800x600	ATTF-060060	ATPO-060180	ATRE-060180	ATPX-060180	ATMF-001800

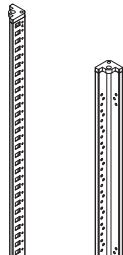
FLAT-PACK CABINET

					
dimensions W x H x D	top and bottom	blank door with front uprights	rear panel with rear uprights	glazed door with front uprights	pair of front uprights for multiple doors cabinet
600x1800x800	ATTF-060080	ATPO-060180	ATRE-060180	ATPX-060180	ATMF-001800
600x2000x400	ATTF-060040	ATPO-060200	ATRE-060200	ATPX-060200	ATMF-002000
600x2000x500	ATTF-060050	ATPO-060200	ATRE-060200	ATPX-060200	ATMF-002000
600x2000x600	ATTF-060060	ATPO-060200	ATRE-060200	ATPX-060200	ATMF-002000
600x2000x800	ATTF-060080	ATPO-060200	ATRE-060200	ATPX-060200	ATMF-002000
600x2000x1000					
600x2200x500	ATTF-060050	ATPO-060220	ATRE-060220	ATPX-060220	
600x2200x600	ATTF-060060	ATPO-060220	ATRE-060220	ATPX-060220	
600x2200x800	ATTF-060080	ATPO-060220	ATRE-060220	ATPX-060220	
800x1400x400	ATTF-080040	ATPO-080140	ATRE-080140	ATPX-080140	
800x1400x500	ATTF-080050	ATPO-080140	ATRE-080140	ATPX-080140	
800x1600x400	ATTF-080040	ATPO-080160	ATRE-080160	ATPX-080160	
800x1600x500	ATTF-080050	ATPO-080160	ATRE-080160	ATPX-080160	
800x1600x600	ATTF-080060	ATPO-080160	ATRE-080160	ATPX-080160	
800x1800x400	ATTF-080040	ATPO-080180	ATRE-080180	ATPX-080180	ATMF-001800
800x1800x500	ATTF-080050	ATPO-080180	ATRE-080180	ATPX-080180	ATMF-001800
800x1800x600	ATTF-080060	ATPO-080180	ATRE-080180	ATPX-080180	ATMF-001800
800x1800x800	ATTF-080080	ATPO-080180	ATRE-080180	ATPX-080180	ATMF-001800
800x2000x400	ATTF-080040	ATPO-080200	ATRE-080200	ATPX-080200	ATMF-002000
800x2000x500	ATTF-080050	ATPO-080200	ATRE-080200	ATPX-080200	ATMF-002000
800x2000x600	ATTF-080060	ATPO-080200	ATRE-080200	ATPX-080200	ATMF-002000
800x2000x800	ATTF-080080	ATPO-080200	ATRE-080200	ATPX-080200	ATMF-002000
800x2000x1000					
800x2200x500	ATTF-080050	ATPO-080220	ATRE-080220	ATPX-080220	
800x2200x600	ATTF-080060	ATPO-080220	ATRE-080220	ATPX-080220	
800x2200x800	ATTF-080080	ATPO-080220	ATRE-080220	ATPX-080220	
1000x1600x400	ATTF-100040	ATPO-100160 *	ATRE-100160	ATPX-100160	
1000x1600x500	ATTF-100050	ATPO-100160 *	ATRE-100160	ATPX-100160	
1000x1600x600	ATTF-100060	ATPO-100160 *	ATRE-100160	ATPX-100160	
1000x1800x400	ATTF-100040	ATPO-100180 *	ATRE-100180	ATPX-100180	
1000x1800x500	ATTF-100050	ATPO-100180 *	ATRE-100180	ATPX-100180	
1000x1800x600	ATTF-100060	ATPO-100180 *	ATRE-100180	ATPX-100180	
1000x1800x800	ATTF-100080	ATPO-100180 *	ATRE-100180	ATPX-100180	
1000x2000x400	ATTF-100040	ATPO-100200 *	ATRE-100200	ATPX-100200	
1000x2000x500	ATTF-100050	ATPO-100200 *	ATRE-100200	ATPX-100200	
1000x2000x600	ATTF-100060	ATPO-100200 *	ATRE-100200	ATPX-100200	
1000x2000x800	ATTF-100080	ATPO-100200 *	ATRE-100200	ATPX-100200	
1000x2200x500	ATTF-100050	ATPO-100220 *	ATRE-100220	ATPX-100220	



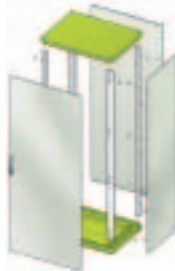
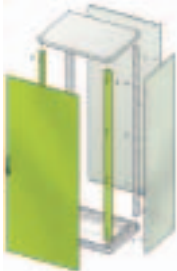

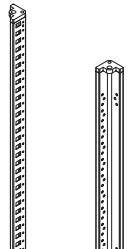
* Single door; to order double door 500+500, please add the suffix DP (i.e. ATPO-100160DP).

FLAT-PACK CABINET

					
dimensions W x H x D	top and bottom	blank door with front uprights	rear panel with rear uprights	glazed door with front uprights	pair of front uprights for multiple doors cabinet
1000x2200x600	ATTF-100060	ATPO-100220 *	ATRE-100220	ATPX-100220	
1000x2200x800	ATTF-100080	ATPO-100220 *	ATRE-100220	ATPX-100220	
1200x1400x400	ATTF-120040	ATPO-120140	ATRE-120140		
1200x1400x500	ATTF-120050	ATPO-120140	ATRE-120140		
1200x1600x400	ATTF-120040	ATPO-120160	ATRE-120160		
1200x1600x500	ATTF-120050	ATPO-120160	ATRE-120160		
1200x1600x600	ATTF-120060	ATPO-120160	ATRE-120160		
1200x1800x400	ATTF-120040	ATPO-120180	ATRE-120180		
1200x1800x500	ATTF-120050	ATPO-120180	ATRE-120180		
1200x1800x600	ATTF-120060	ATPO-120180	ATRE-120180		
1200x1800x800	ATTF-120080	ATPO-120180	ATRE-120180		
1200x2000x400	ATTF-120040	ATPO-120200	ATRE-120200		
1200x2000x500	ATTF-120050	ATPO-120200	ATRE-120200		
1200x2000x600	ATTF-120060	ATPO-120200	ATRE-120200		
1200x2000x800	ATTF-120080	ATPO-120200	ATRE-120200		
1200x2000x1000					
1200x2200x500	ATTF-120050	ATPO-120220	ATRE-120220		
1200x2200x600	ATTF-120060	ATPO-120220	ATRE-120220		
1200x2200x800	ATTF-120080	ATPO-120220	ATRE-120220		
1400x2000x400	ATTF-140040	ATPO-140200	ATRE-140200		
1400x2000x500	ATTF-140050	ATPO-140200	ATRE-140200		
1400x2000x600	ATTF-140060	ATPO-140200	ATRE-140200		
1400x2000x800	ATTF-140080	ATPO-140200	ATRE-140200		
1600x1400x400	ATTF-160040	ATPO-160140	ATRE-160140		
1600x1400x500	ATTF-160050	ATPO-160140	ATRE-160140		
1600x2000x400	ATTF-160040	ATPO-160200	ATRE-160200		
1600x2000x500	ATTF-160050	ATPO-160200	ATRE-160200		
1600x2000x600	ATTF-160060	ATPO-160200	ATRE-160200		
1600x2000x800	ATTF-160080	ATPO-160200	ATRE-160200		



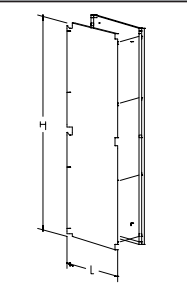

* Single door; to order double door 500+500, please add the suffix DP (i.e. ATPO-100160DP).

COMPLEMENTARY ACCESSORIES

						
dimensions W x H x D	cable entry module front opening (4)	cable entry module side opening W=200mm	cable entry module side opening W=300mm	front inserted mounting plate (5)	infill plate	supplementary mounting plate
200x1800x500		ATRP-021805				
200x2000x600		ATRP-022006				
300x1600x400	CE1000-031604					
300x1600x500	CE1000-031605					
300x1600x600	CE1000-031606					
300x1800x400	CE1000-031804					
300x1800x500	CE1000-031805		ATRP-031805			
300x1800x600	CE1000-031806		ATRP-031806			
300x1800x800	CE1000-031808		ATRP-031808			
300x2000x400	CE1000-032004					
300x2000x500	CE1000-032005		ATRP-032005			
300x2000x600	CE1000-032006		ATRP-032006			
300x2000x800	CE1000-032008		ATRP-032008			
300x2200x500	CE1000-032205					
300x2200x600	CE1000-032206					
300x2200x800	CE1000-032208					
400x1600x400				ATPA-040160	ATPN-001600	ATPS-040160
400x1600x500				ATPA-040160	ATPN-001600	ATPS-040160
400x1600x600				ATPA-040160	ATPN-001600	ATPS-040160
400x1800x400				ATPA-040180	ATPN-001800	ATPS-040180
400x1800x500				ATPA-040180	ATPN-001800	ATPS-040180
400x1800x600				ATPA-040180	ATPN-001800	ATPS-040180
400x1800x800				ATPA-040180	ATPN-001800	ATPS-040180
400x2000x400				ATPA-040200	ATPN-002000	ATPS-040200
400x2000x500				ATPA-040200	ATPN-002000	ATPS-040200
400x2000x600				ATPA-040200	ATPN-002000	ATPS-040200
400x2000x800				ATPA-040200	ATPN-002000	ATPS-040200
400x2200x500				ATPA-040220	ATPN-002200	ATPS-040220
400x2200x600				ATPA-040220	ATPN-002200	ATPS-040220
400x2200x800				ATPA-040220	ATPN-002200	ATPS-040220
600x1400x400				ATPA-060140	ATPN-001400	ATPS-060140
600x1400x500				ATPA-060140	ATPN-001400	ATPS-060140
600x1600x400				ATPA-060160	ATPN-001600	ATPS-060160
600x1600x500				ATPA-060160	ATPN-001600	ATPS-060160
600x1600x600				ATPA-060160	ATPN-001600	ATPS-060160
600x1800x400				ATPA-060180	ATPN-001800	ATPS-060180
600x1800x500				ATPA-060180	ATPN-001800	ATPS-060180
600x1800x600				ATPA-060180	ATPN-001800	ATPS-060180

(4) supply includes the cabinet frame, front door and rear panel. To be ordered separately plinth, side panels and eyebolts WTGS-001 (page 11)

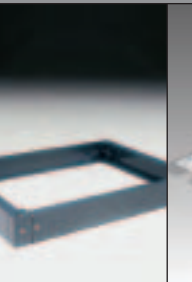
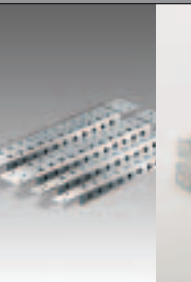
(5) to be ordered separately mounting accessories WTKB-002





COMPLEMENTARY ACCESSORIES						
						
dimensions W x H x D	side inserted mounting plate	inner door	side panels (6)	plinth H=100mm	fast fixing brackets H=25mm (7)	rails H=50mm (8)
200x1800x500						
200x2000x600						
300x1600x400			ATFI-040160	ATZ1-030040		
300x1600x500			ATFI-050160	ATZ1-030050		
300x1600x600			ATFI-060160	ATZ1-030060		
300x1800x400			ATFI-040180	ATZ1-030040		
300x1800x500			ATFI-050180	ATZ1-030050		
300x1800x600			ATFI-060180	ATZ1-030060		
300x1800x800			ATFI-080180	ATZ1-030080		
300x2000x400			ATFI-040200	ATZ1-030040		
300x2000x500			ATFI-050200	ATZ1-030050		
300x2000x600			ATFI-060200	ATZ1-030060		
300x2000x800			ATFI-080200	ATZ1-030080		
300x2200x500			ATFI-050220	ATZ1-030050		
300x2200x600			ATFI-060220	ATZ1-030060		
300x2200x800			ATFI-080220	ATZ1-030080		
400x1600x400	ATPL-040160		ATFI-040160	ATZ1-040040	WTPR-025040R	WTPR-050040
400x1600x500	ATPL-040160		ATFI-050160	ATZ1-040050	WTPR-025050R	WTPR-050050
400x1600x600	ATPL-040160		ATFI-060160	ATZ1-040060	WTPR-025060R	WTPR-050060
400x1800x400	ATPL-040180		ATFI-040180	ATZ1-040040	WTPR-025040R	WTPR-050040
400x1800x500	ATPL-040180		ATFI-050180	ATZ1-040050	WTPR-025050R	WTPR-050050
400x1800x600	ATPL-040180		ATFI-060180	ATZ1-040060	WTPR-025060R	WTPR-050060
400x1800x800	ATPL-040180		ATFI-080180	ATZ1-040080	WTPR-025080R	WTPR-050080
400x2000x400	ATPL-040200		ATFI-040200	ATZ1-040040	WTPR-025040R	WTPR-050040
400x2000x500	ATPL-040200		ATFI-050200	ATZ1-040050	WTPR-025050R	WTPR-050050
400x2000x600	ATPL-040200		ATFI-060200	ATZ1-040060	WTPR-025060R	WTPR-050060
400x2000x800	ATPL-040200		ATFI-080200	ATZ1-040080	WTPR-025080R	WTPR-050080
400x2200x500	ATPL-040220		ATFI-050220	ATZ1-040050	WTPR-025050R	WTPR-050050
400x2200x600	ATPL-040220		ATFI-060220	ATZ1-040060	WTPR-025060R	WTPR-050060
400x2200x800	ATPL-040220		ATFI-080220	ATZ1-040080	WTPR-025080R	WTPR-050080
600x1400x400	ATPL-060140	ATPI-060140	ATFI-040140	ATZ1-060040	WTPR-025040R	WTPR-050040
600x1400x500	ATPL-060140	ATPI-060140	ATFI-050140	ATZ1-060050	WTPR-025050R	WTPR-050050
600x1600x400	ATPL-060160	ATPI-060160	ATFI-040160	ATZ1-060040	WTPR-025040R	WTPR-050040
600x1600x500	ATPL-060160	ATPI-060160	ATFI-050160	ATZ1-060050	WTPR-025050R	WTPR-050050
600x1600x600	ATPL-060160	ATPI-060160	ATFI-060160	ATZ1-060060	WTPR-025060R	WTPR-050060
600x1800x400	ATPL-060180	ATPI-060180	ATFI-040180	ATZ1-060040	WTPR-025040R	WTPR-050040
600x1800x500	ATPL-060180	ATPI-060180	ATFI-050180	ATZ1-060050	WTPR-025050R	WTPR-050050
600x1800x600	ATPL-060180	ATPI-060180	ATFI-060180	ATZ1-060060	WTPR-025060R	WTPR-050060

(6) supply includes 2 pieces

(7) supply includes 4 pieces

(8) supply includes 4 pieces. To be ordered separately fixing brackets WTSF-001 (see 'supplementary accessories')

COMPLEMENTARY ACCESSORIES

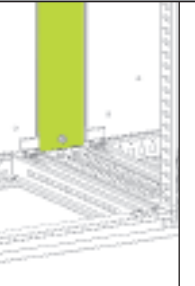
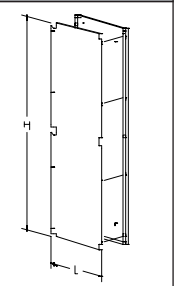
						
dimensions W x H x D	cable entry module front opening	cable entry module side opening W=200mm	cable entry module side opening W=300mm	front inserted mounting plate (5)	infill plate	supplementary mounting plate
600x1800x800				ATPA-060180	ATPN-001800	ATPS-060180
600x2000x400				ATPA-060200	ATPN-002000	ATPS-060200
600x2000x500				ATPA-060200	ATPN-002000	ATPS-060200
600x2000x600				ATPA-060200	ATPN-002000	ATPS-060200
600x2000x800				ATPA-060200	ATPN-002000	ATPS-060200
600x2000x1000				ATPA-060200	ATPN-002000	ATPS-060200
600x2200x500				ATPA-060220	ATPN-002200	ATPS-060220
600x2200x600				ATPA-060220	ATPN-002200	ATPS-060220
600x2200x800				ATPA-060220	ATPN-002200	ATPS-060220
800x1400x400				ATPA-080140	ATPN-001400	ATPS-080140
800x1400x500				ATPA-080140	ATPN-001400	ATPS-080140
800x1600x400				ATPA-080160	ATPN-001600	ATPS-080160
800x1600x500				ATPA-080160	ATPN-001600	ATPS-080160
800x1600x600				ATPA-080160	ATPN-001600	ATPS-080160
800x1800x400				ATPA-080180	ATPN-001800	ATPS-080180
800x1800x500				ATPA-080180	ATPN-001800	ATPS-080180
800x1800x600				ATPA-080180	ATPN-001800	ATPS-080180
800x1800x800				ATPA-080180	ATPN-001800	ATPS-080180
800x2000x400				ATPA-080200	ATPN-002000	ATPS-080200
800x2000x500				ATPA-080200	ATPN-002000	ATPS-080200
800x2000x600				ATPA-080200	ATPN-002000	ATPS-080200
800x2000x800				ATPA-080200	ATPN-002000	ATPS-080200
800x2000x1000				ATPA-080200	ATPN-002000	ATPS-080200
800x2200x500				ATPA-080220	ATPN-002200	ATPS-080220
800x2200x600				ATPA-080220	ATPN-002200	ATPS-080220
800x2200x800				ATPA-080220	ATPN-002200	ATPS-080220
1000x1600x400				ATPA-100160	ATPN-001600	ATPS-100160
1000x1600x500				ATPA-100160	ATPN-001600	ATPS-100160
1000x1600x600				ATPA-100160	ATPN-001600	ATPS-100160
1000x1800x400				ATPA-100180	ATPN-001800	ATPS-100180
1000x1800x500				ATPA-100180	ATPN-001800	ATPS-100180
1000x1800x600				ATPA-100180	ATPN-001800	ATPS-100180
1000x1800x800				ATPA-100180	ATPN-001800	ATPS-100180
1000x2000x400				ATPA-100200	ATPN-002000	ATPS-100200
1000x2000x500				ATPA-100200	ATPN-002000	ATPS-100200
1000x2000x600				ATPA-100200	ATPN-002000	ATPS-100200
1000x2000x800				ATPA-100200	ATPN-002000	ATPS-100200
1000x2200x500				ATPA-100220	ATPN-002200	ATPS-100220

(5) to be ordered separately mounting accessories WTKB-002





COMPLEMENTARY ACCESSORIES						
						
dimensions W x H x D	side inserted mounting plate	inner door	side panels (6)	plinth H=100mm	fast fixing brackets H=25mm (7)	rails H=50mm (8)
600x1800x800	ATPL-060180	ATPI-060180	ATFI-080180	ATZ1-060080	WTPR-025080R	WTPR-050080
600x2000x400	ATPL-060200	ATPI-060200	ATFI-040200	ATZ1-060040	WTPR-025040R	WTPR-050040
600x2000x500	ATPL-060200	ATPI-060200	ATFI-050200	ATZ1-060050	WTPR-025050R	WTPR-050050
600x2000x600	ATPL-060200	ATPI-060200	ATFI-060200	ATZ1-060060	WTPR-025060R	WTPR-050060
600x2000x800	ATPL-060200	ATPI-060200	ATFI-080200	ATZ1-060080	WTPR-025080R	WTPR-050080
600x2000x1000	ATPL-060200	ATPI-060200	ATFI-100200	ATZ1-060100	WTPR-025100R	WTPR-050100
600x2200x500	ATPL-060220	ATPI-060220	ATFI-050220	ATZ1-060050	WTPR-025050R	WTPR-050050
600x2200x600	ATPL-060220	ATPI-060220	ATFI-060220	ATZ1-060060	WTPR-025060R	WTPR-050060
600x2200x800	ATPL-060220	ATPI-060220	ATFI-080220	ATZ1-060080	WTPR-025080R	WTPR-050080
800x1400x400	ATPL-080140	ATPI-080140	ATFI-040140	ATZ1-080040	WTPR-025040R	WTPR-050040
800x1400x500	ATPL-080140	ATPI-080140	ATFI-050140	ATZ1-080050	WTPR-025050R	WTPR-050050
800x1600x400	ATPL-080160	ATPI-080160	ATFI-040160	ATZ1-080040	WTPR-025040R	WTPR-050040
800x1600x500	ATPL-080160	ATPI-080160	ATFI-050160	ATZ1-080050	WTPR-025050R	WTPR-050050
800x1600x600	ATPL-080160	ATPI-080160	ATFI-060160	ATZ1-080060	WTPR-025060R	WTPR-050060
800x1800x400	ATPL-080180	ATPI-080180	ATFI-040180	ATZ1-080040	WTPR-025040R	WTPR-050040
800x1800x500	ATPL-080180	ATPI-080180	ATFI-050180	ATZ1-080050	WTPR-025050R	WTPR-050050
800x1800x600	ATPL-080180	ATPI-080180	ATFI-060180	ATZ1-080060	WTPR-025060R	WTPR-050060
800x1800x800	ATPL-080180	ATPI-080180	ATFI-080180	ATZ1-080080	WTPR-025080R	WTPR-050080
800x2000x400	ATPL-080200	ATPI-080200	ATFI-040200	ATZ1-080040	WTPR-025040R	WTPR-050040
800x2000x500	ATPL-080200	ATPI-080200	ATFI-050200	ATZ1-080050	WTPR-025050R	WTPR-050050
800x2000x600	ATPL-080200	ATPI-080200	ATFI-060200	ATZ1-080060	WTPR-025060R	WTPR-050060
800x2000x800	ATPL-080200	ATPI-080200	ATFI-080200	ATZ1-080080	WTPR-025080R	WTPR-050080
800x2000x1000	ATPL-080200	ATPI-080200	ATFI-100200	ATZ1-080100	WTPR-025100R	WTPR-050100
800x2200x500	ATPL-080220	ATPI-080220	ATFI-050220	ATZ1-080050	WTPR-025050R	WTPR-050050
800x2200x600	ATPL-080220	ATPI-080220	ATFI-060220	ATZ1-080060	WTPR-025060R	WTPR-050060
800x2200x800	ATPL-080220	ATPI-080220	ATFI-080220	ATZ1-080080	WTPR-025080R	WTPR-050080
1000x1600x400	ATPL-100160	ATPI-100160	ATFI-040160	ATZ1-100040	WTPR-025040R	WTPR-050040
1000x1600x500	ATPL-100160	ATPI-100160	ATFI-050160	ATZ1-100050	WTPR-025050R	WTPR-050050
1000x1600x600	ATPL-100160	ATPI-100160	ATFI-060160	ATZ1-100060	WTPR-025060R	WTPR-050060
1000x1800x400	ATPL-100180	ATPI-100180	ATFI-040180	ATZ1-100040	WTPR-025040R	WTPR-050040
1000x1800x500	ATPL-100180	ATPI-100180	ATFI-050180	ATZ1-100050	WTPR-025050R	WTPR-050050
1000x1800x600	ATPL-100180	ATPI-100180	ATFI-060180	ATZ1-100060	WTPR-025060R	WTPR-050060
1000x1800x800	ATPL-100180	ATPI-100180	ATFI-080180	ATZ1-100080	WTPR-025080R	WTPR-050080
1000x2000x400	ATPL-100200	ATPI-100200	ATFI-040200	ATZ1-100040	WTPR-025040R	WTPR-050040
1000x2000x500	ATPL-100200	ATPI-100200	ATFI-050200	ATZ1-100050	WTPR-025050R	WTPR-050050
1000x2000x600	ATPL-100200	ATPI-100200	ATFI-060200	ATZ1-100060	WTPR-025060R	WTPR-050060
1000x2000x800	ATPL-100200	ATPI-100200	ATFI-080200	ATZ1-100080	WTPR-025080R	WTPR-050080
1000x2200x500	ATPL-100220	ATPI-100220	ATFI-050220	ATZ1-100050	WTPR-025050R	WTPR-050050

(6) supply includes 2 pieces

(7) supply includes 4 pieces

(8) supply includes 4 pieces. To be ordered separately fixing brackets WTSF-001 (see 'supplementary accessories')

COMPLEMENTARY ACCESSORIES

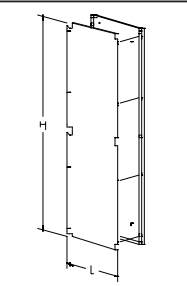
						
dimensions W x H x D	cable entry module front opening	cable entry module side opening W=200mm	cable entry module side opening W=300mm	front inserted mounting plate (5)	infill plate	supplementary mounting plate
1000x2200x600				ATPA-100220	ATPN-002200	ATPS-100220
1000x2200x800				ATPA-100220	ATPN-002200	ATPS-100220
1200x1400x400				ATPA-120140	ATPN-001400	
1200x1400x500				ATPA-120140	ATPN-001400	
1200x1600x400				ATPA-120160	ATPN-001600	
1200x1600x500				ATPA-120160	ATPN-001600	
1200x1600x600				ATPA-120160	ATPN-001600	
1200x1800x400				ATPA-120180	ATPN-001800	
1200x1800x500				ATPA-120180	ATPN-001800	
1200x1800x600				ATPA-120180	ATPN-001800	
1200x1800x800				ATPA-120180	ATPN-001800	
1200x2000x400				ATPA-120200	ATPN-002000	
1200x2000x500				ATPA-120200	ATPN-002000	
1200x2000x600				ATPA-120200	ATPN-002000	
1200x2000x800				ATPA-120200	ATPN-002000	
1200x2000x1000				ATPA-120200	ATPN-002000	
1200x2200x500				ATPA-120220	ATPN-002200	
1200x2200x600				ATPA-120220	ATPN-002200	
1200x2200x800				ATPA-120220	ATPN-002200	
1400x2000x400				ATPA-140200	ATPN-002000	
1400x2000x500				ATPA-140200	ATPN-002000	
1400x2000x600				ATPA-140200	ATPN-002000	
1400x2000x800				ATPA-140200	ATPN-002000	
1600x1400x400				ATPA-160140	ATPN-001400	
1600x1400x500				ATPA-160140	ATPN-001400	
1600x2000x400				ATPA-160200	ATPN-002000	
1600x2000x500				ATPA-160200	ATPN-002000	
1600x2000x600				ATPA-160200	ATPN-002000	
1600x2000x800				ATPA-160200	ATPN-002000	

(5) to be ordered separately mounting accessories WTKB-002

COMPLEMENTARY ACCESSORIES						
dimensions W x H x D	side inserted mounting plate	inner door	side panels (6)	plinth H=100mm	fast fixing brackets H=25mm (7)	rails H=50mm (8)
1000x2200x600	ATPL-100220	ATPI-100220	ATFI-060220	ATZ1-100060	WTPR-025060R	WTPR-050060
1000x2200x800	ATPL-100220	ATPI-100220	ATFI-080220	ATZ1-100080	WTPR-025080R	WTPR-050080
1200x1400x400	ATPL-120140		ATFI-040140	ATZ1-120040	WTPR-025040R	WTPR-050040
1200x1400x500	ATPL-120140		ATFI-050140	ATZ1-120050	WTPR-025050R	WTPR-050050
1200x1600x400	ATPL-120160		ATFI-040160	ATZ1-120040	WTPR-025040R	WTPR-050040
1200x1600x500	ATPL-120160		ATFI-050160	ATZ1-120050	WTPR-025050R	WTPR-050050
1200x1600x600	ATPL-120160		ATFI-060160	ATZ1-120060	WTPR-025060R	WTPR-050060
1200x1800x400	ATPL-120180		ATFI-040180	ATZ1-120040	WTPR-025040R	WTPR-050040
1200x1800x500	ATPL-120180		ATFI-050180	ATZ1-120050	WTPR-025050R	WTPR-050050
1200x1800x600	ATPL-120180		ATFI-060180	ATZ1-120060	WTPR-025060R	WTPR-050060
1200x1800x800	ATPL-120180		ATFI-080180	ATZ1-120080	WTPR-025080R	WTPR-050080
1200x2000x400	ATPL-120200		ATFI-040200	ATZ1-120040	WTPR-025040R	WTPR-050040
1200x2000x500	ATPL-120200		ATFI-050200	ATZ1-120050	WTPR-025050R	WTPR-050050
1200x2000x600	ATPL-120200		ATFI-060200	ATZ1-120060	WTPR-025060R	WTPR-050060
1200x2000x800	ATPL-120200		ATFI-080200	ATZ1-120080	WTPR-025080R	WTPR-050080
1200x2000x1000	ATPL-120200		ATFI-100200	ATZ1-120100	WTPR-025100R	WTPR-050100
1200x2200x500	ATPL-120220		ATFI-050220	ATZ1-120050	WTPR-025050R	WTPR-050050
1200x2200x600	ATPL-120220		ATFI-060220	ATZ1-120060	WTPR-025060R	WTPR-050060
1200x2200x800	ATPL-120220		ATFI-080220	ATZ1-120080	WTPR-025080R	WTPR-050080
1400x2000x400	ATPL-140200		ATFI-040200	ATZ1-140040	WTPR-025040R	WTPR-050040
1400x2000x500	ATPL-140200		ATFI-050200	ATZ1-140050	WTPR-025050R	WTPR-050050
1400x2000x600	ATPL-140200		ATFI-060200	ATZ1-140060	WTPR-025060R	WTPR-050060
1400x2000x800	ATPL-140200		ATFI-080200	ATZ1-140080	WTPR-025080R	WTPR-050080
1600x1400x400	ATPL-160140		ATFI-040140	ATZ1-160040	WTPR-025040R	WTPR-050040
1600x1400x500	ATPL-160140		ATFI-050140	ATZ1-160050	WTPR-025050R	WTPR-050050
1600x2000x400	ATPL-160200		ATFI-040200	ATZ1-160040	WTPR-025040R	WTPR-050040
1600x2000x500	ATPL-160200		ATFI-050200	ATZ1-160050	WTPR-025050R	WTPR-050050
1600x2000x600	ATPL-160200		ATFI-060200	ATZ1-160060	WTPR-025060R	WTPR-050060
1600x2000x800	ATPL-160200		ATFI-080200	ATZ1-160080	WTPR-025080R	WTPR-050080

(6) supply includes 2 pieces

(7) supply includes 4 pieces

(8) supply includes 4 pieces. To be ordered separately fixing brackets WTSF-001 (see 'supplementary accessories')

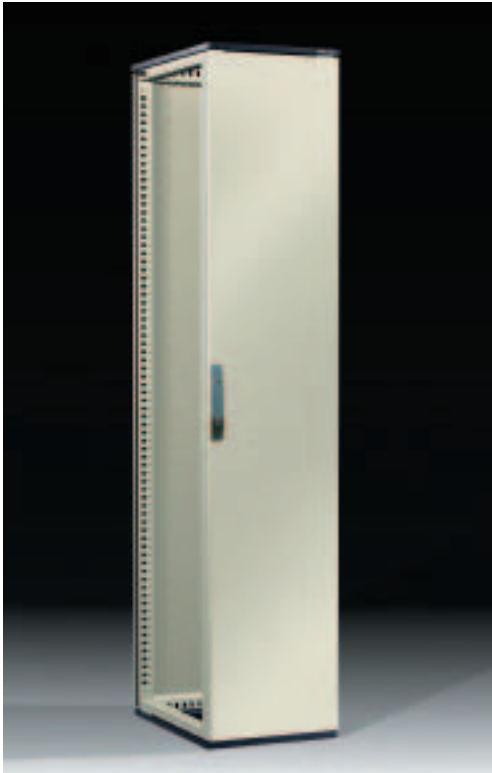

characteristics

• STRUCTURE

Profile and rails are made up of a unique closed profile manufactured from 1.5mm sheet steel, fully welded and with rounded edges. The frame corners are manufactured with orthogonal joints laser welded to vertical upright rails and horizontal rails for the roof and bottom. Only 8 high resistance screws are necessary to mount the structure, while two position pins allow the easy mounting of the two parts of the joint.

paint finish

CE-TEK standard epoxy polyester powder coating.
Structure, door and rear panel RAL 7032 textured finish.
Roof and bottom RAL 7025 textured finish.

assembled cabinet (PR)

Supply includes:

- structure
- door manufactured from 2mm sheet steel with stiffening frame, complete with Ø 3mm double bar locking system
- rear panel manufactured from 1.5mm sheet steel
- removable roof manufactured from 1.5mm sheet steel
- bottom with adjustable cable entry manufactured from 1.5mm sheet steel.

flat-pack cabinet

Supply includes:

- composition to be assembled complying with customers requests
- panels and doors are supplied together with two vertical uprights complete with accessories.

conformity and approval



conformity and approval assembled cabinet



conformity and approval flat-pack cabinet



protection degree

- IP 55 complying with EN50298; EN60529
- type 12 complying with UL508A; UL50
- impact resistance IK10 complying with EN500298; EN50102.

To be ordered separately eyebolts and/or lifting brackets: see 'complementary accessories'.

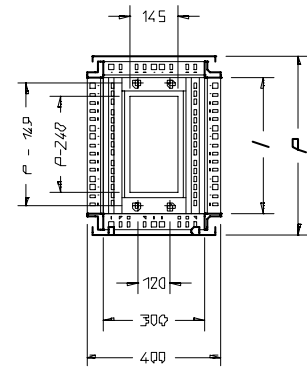
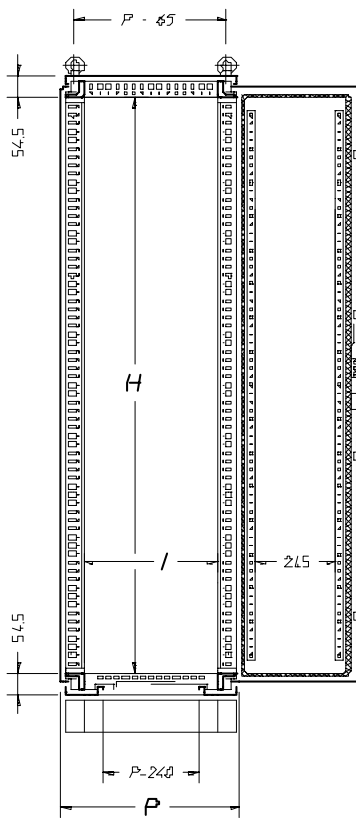
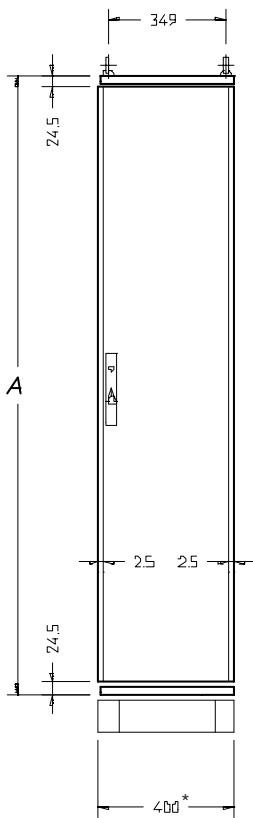

* With side panels mounted L = 416mm

code		cabinet dim.		usable internal area	
mod.	art.	A	P	H	I
CE1000	041604PR	1609	414	1500	300
	041605PR		514		400
	041606PR		614		500
	041804PR	1809	414	1700	300
	041805PR		514		400
	041806PR		614		500
	041808PR	2009	814	1900	700
	042004PR		414		300
	042005PR		514		400
	042006PR	2209	614	2100	500
	042008PR		814		700
	042205PR		514		400
	042206PR	2209	614	2100	500
	042208PR		814		700

assembled cabinet

cabinet dimensions			blank door + rear panel	front + rear blank doors
width	height	depth		
400	1600	400	CE1000-041604PR	CE1000-041604DP
400	1600	500	CE1000-041605PR	CE1000-041605DP
400	1600	600	CE1000-041606PR	CE1000-041606DP
400	1800	400	CE1000-041804PR	CE1000-041804DP
400	1800	500	CE1000-041805PR	CE1000-041805DP
400	1800	600	CE1000-041806PR	CE1000-041806DP
400	1800	800	CE1000-041808PR	CE1000-041808DP
400	2000	400	CE1000-042004PR	CE1000-042004DP
400	2000	500	CE1000-042005PR	CE1000-042005DP
400	2000	600	CE1000-042006PR	CE1000-042006DP
400	2000	800	CE1000-042008PR	CE1000-042008DP
400	2200	500	CE1000-042205PR	CE1000-042205DP
400	2200	600	CE1000-042206PR	CE1000-042206DP
400	2200	800	CE1000-042208PR	CE1000-042208DP

flat-pack cabinet

cabinet dimensions			roof + bottom	blank door	rear panel
width	height	depth			
400	1600	400	ATTF-040040	ATPO-040160	ATRE-040160
400	1600	500	ATTF-040050	ATPO-040160	ATRE-040160
400	1600	600	ATTF-040060	ATPO-040160	ATRE-040160
400	1800	400	ATTF-040040	ATPO-040180	ATRE-040180
400	1800	500	ATTF-040050	ATPO-040180	ATRE-040180
400	1800	600	ATTF-040060	ATPO-040180	ATRE-040180
400	1800	800	ATTF-040080	ATPO-040180	ATRE-040180
400	2000	400	ATTF-040040	ATPO-040200	ATRE-040200
400	2000	500	ATTF-040050	ATPO-040200	ATRE-040200
400	2000	600	ATTF-040060	ATPO-040200	ATRE-040200
400	2000	800	ATTF-040080	ATPO-040200	ATRE-040200
400	2200	500	ATTF-040050	ATPO-040220	ATRE-040220
400	2200	600	ATTF-040060	ATPO-040220	ATRE-040220
400	2200	800	ATTF-040080	ATPO-040220	ATRE-040220



characteristics

• STRUCTURE

Profile and rails are made up of a unique closed profile manufactured from 1.5mm sheet steel, fully welded and with rounded edges. The frame corners are manufactured with orthogonal joints laser welded to vertical upright rails and horizontal rails for the roof and bottom. Only 8 high resistance screws are necessary to mount the structure, while two position pins allow the easy mounting of the two parts of the joint.

paint finish

CE-TEK standard epoxy polyester powder coating.
Structure, door and rear panel RAL 7032 textured finish.
Roof and bottom RAL 7025 textured finish.

assembled cabinet (PR)

Supply includes:

- structure
- door manufactured from 2mm sheet steel with stiffening frame, complete with Ø 3mm double bar locking system
- rear panel manufactured from 1.5mm sheet steel
- removable roof manufactured from 1.5mm sheet steel
- bottom with adjustable cable entry manufactured from 1.5mm sheet steel.

flat-pack cabinet

Supply includes:

- composition to be assembled complying with customers requests
- panels and doors are supplied together with two vertical uprights complete with accessories.

conformity and approval



conformity and approval assembled cabinet



conformity and approval flat-pack cabinet



protection degree

- IP 55 complying with EN50298; EN60529
- type 12 complying with UL508A; UL50
- impact resistance IK10 complying with EN500298; EN50102.

To be ordered separately eyebolts and/or lifting brackets: see 'complementary accessories'.

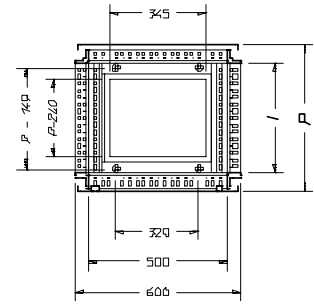
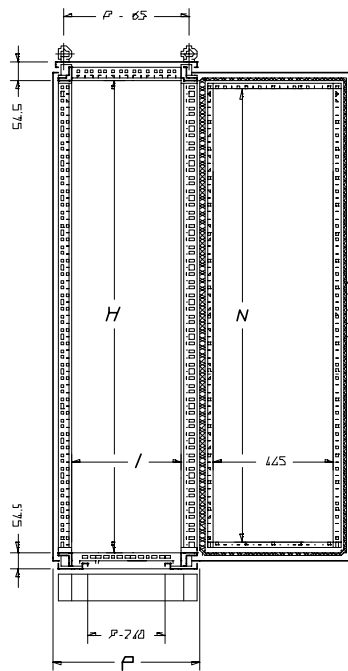
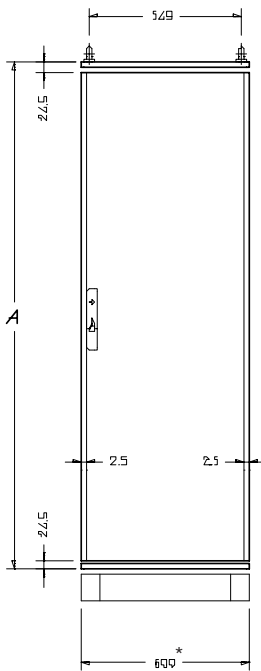

* With side panels mounted L = 616 mm

code		cabinet dim.		usable internal area		
mod.	art.	A	P	H	I	N
CE1000	061404PR	1409	414	1300	300	1230
	061405PR		514		400	
	061604PR	1609	414	1500	300	1430
	061605PR		514		400	
	061606PR		614		500	
	061804PR	1809	414	1700	300	1630
	061805PR		514		400	
	061806PR		614		500	
	061808PR		814		700	
	062004PR	2009	414	1900	300	1830
	062005PR		514		400	
	062006PR		614		500	
	062008PR		814		700	
	062205PR	2209	1014	2100	900	2030
	062206PR		514		400	
	062208PR		614		500	
			814		700	

assembled cabinet

cabinet dimensions			blank door + rear panel	glazed door + rear panel	front + rear blank door
width	height	depth			
600	1400	400	CE1000-061404PR	CE1000-061404PX	CE1000-061404DP
600	1400	500	CE1000-061405PR	CE1000-061405PX	CE1000-061405DP
600	1600	400	CE1000-061604PR	CE1000-061604PX	CE1000-061604DP
600	1600	500	CE1000-061605PR	CE1000-061605PX	CE1000-061605DP
600	1600	600	CE1000-061606PR	CE1000-061606PX	CE1000-061606DP
600	1800	400	CE1000-061804PR	CE1000-061804PX	CE1000-061804DP
600	1800	500	CE1000-061805PR	CE1000-061805PX	CE1000-061805DP
600	1800	600	CE1000-061806PR	CE1000-061806PX	CE1000-061806DP
600	1800	800	CE1000-061808PR	CE1000-061808PX	CE1000-061808DP
600	2000	400	CE1000-062004PR	CE1000-062004PX	CE1000-062004DP
600	2000	500	CE1000-062005PR	CE1000-062005PX	CE1000-062005DP
600	2000	600	CE1000-062006PR	CE1000-062006PX	CE1000-062006DP
600	2000	800	CE1000-062008PR	CE1000-062008PX	CE1000-062008DP
			CE1000-062010PR	---	---
600	2200	500	CE1000-062205PR	CE1000-062205PX	CE1000-062205DP

flat-pack cabinet

cabinet dimensions			roof + bottom	blank door	glazed door	rear panel
width	height	depth				
600	1400	400	ATTF-060040	ATPO-060140	ATPX-060140	ATRE-060140
600	1400	500	ATTF-060050	ATPO-060140	ATPX-060140	ATRE-060140
600	1600	400	ATTF-060040	ATPO-060160	ATPX-060160	ATRE-060160
600	1600	500	ATTF-060050	ATPO-060160	ATPX-060160	ATRE-060160
600	1600	600	ATTF-060060	ATPO-060160	ATPX-060160	ATRE-060160
600	1800	400	ATTF-060040	ATPO-060180	ATPX-060180	ATRE-060180
600	1800	500	ATTF-060050	ATPO-060180	ATPX-060180	ATRE-060180
600	1800	600	ATTF-060060	ATPO-060180	ATPX-060180	ATRE-060180
600	1800	800	ATTF-060080	ATPO-060180	ATPX-060180	ATRE-060180
600	2000	400	ATTF-060040	ATPO-060200	ATPX-060200	ATRE-060200
600	2000	500	ATTF-060050	ATPO-060200	ATPX-060200	ATRE-060200
600	2000	600	ATTF-060060	ATPO-060200	ATPX-060200	ATRE-060200
600	2000	800	ATTF-060080	ATPO-060200	ATPX-060200	ATRE-060200
600	2200	500	ATTF-060050	ATPO-060220	ATPX-060220	ATRE-060220
600	2200	600	ATTF-060060	ATPO-060220	ATPX-060220	ATRE-060220
600	2200	800	ATTF-060080	ATPO-060220	ATPX-060220	ATRE-060220



characteristics

• STRUCTURE

Profile and rails are made up of a unique closed profile manufactured from 1.5mm sheet steel, fully welded and with rounded edges. The frame corners are manufactured with orthogonal joints laser welded to vertical upright rails and horizontal rails for the roof and bottom. Only 8 high resistance screws are necessary to mount the structure, while two position pins allow the easy mounting of the two parts of the joint.

paint finish

CE-TEK standard epoxy polyester powder coating.
Structure, door and rear panel RAL 7032 textured finish.
Roof and bottom RAL 7025 textured finish.

assembled cabinet (PR)

Supply includes:

- structure
- door manufactured from 2mm sheet steel with stiffening frame, complete with Ø 3mm double bar locking system
- rear panel manufactured from 1.5mm sheet steel
- removable roof manufactured from 1.5mm sheet steel
- bottom with adjustable cable entry manufactured from 1.5mm sheet steel.

flat-pack cabinet

Supply includes:

- composition to be assembled complying with customers requests
- panels and doors are supplied together with two vertical uprights complete with accessories.

conformity and approval



conformity and approval assembled cabinet



conformity and approval flat-pack cabinet



protection degree

- IP 55 complying with EN50298; EN60529
- type 12 complying with UL508A; UL50
- impact resistance IK10 complying with EN500298; EN50102.

To be ordered separately eyebolts and/or lifting brackets: see 'complementary accessories'.

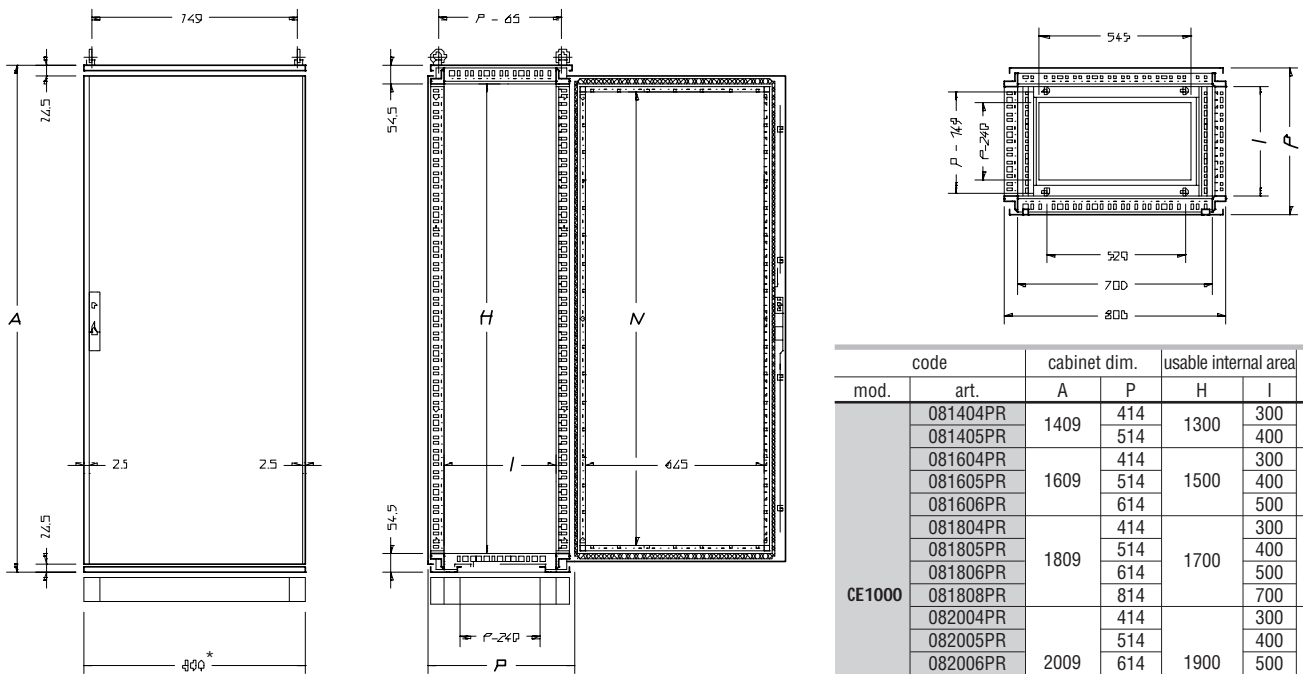

* With side panels mounted L = 816 mm

code		cabinet dim.		usable internal area		
mod.	art.	A	P	H	I	N
CE1000	081404PR	1409	414	1300	300	1230
	081405PR		514		400	
	081604PR	1609	414	1500	300	1430
	081605PR		514		400	
	081606PR		614		500	
	081804PR	1809	414	1700	300	1630
	081805PR		514		400	
	081806PR		614		500	
	081808PR		814		700	
	082004PR	2009	414	1900	300	1830
	082005PR		514		400	
	082006PR		614		500	
	082008PR		814		700	
	082010PR		1014		900	
	082205PR	2209	514	2100	400	2030
	082206PR		614		500	
082208PR	814		700			

assembled cabinet

cabinet dimensions			blank door + rear panel	glazed door + rear panel	front + rear blank doors
width	height	depth			
800	1400	400	CE1000-081404PR	CE1000-081404PX	CE1000-081404DP
800	1400	500	CE1000-081405PR	CE1000-081405PX	CE1000-081405DP
800	1600	400	CE1000-081604PR	CE1000-081604PX	CE1000-081604DP
800	1600	500	CE1000-081605PR	CE1000-081605PX	CE1000-081605DP
800	1600	600	CE1000-081606PR	CE1000-081606PX	CE1000-081606DP
800	1800	400	CE1000-081804PR	CE1000-081804PX	CE1000-081804DP
800	1800	500	CE1000-081805PR	CE1000-081805PX	CE1000-081805DP
800	1800	600	CE1000-081806PR	CE1000-081806PX	CE1000-081806DP
800	1800	800	CE1000-081808PR	CE1000-081808PX	CE1000-081808DP
800	2000	400	CE1000-082004PR	CE1000-082004PX	CE1000-082004DP
800	2000	500	CE1000-082005PR	CE1000-082005PX	CE1000-082005DP
800	2000	600	CE1000-082006PR	CE1000-082006PX	CE1000-082006DP
800	2000	800	CE1000-082008PR	CE1000-082008PX	CE1000-082008DP
			CE1000-082010PR	---	---
800	2200	500	CE1000-082205PR	CE1000-082205PX	CE1000-082205DP
					CE1000-082206DP
					CE1000-082208DP

flat-pack cabinet

cabinet dimensions			roof + bottom	blank door	glazed door	rear panel
width	height	depth				
800	1400	400	ATTF-080040	ATPO-080140	ATPX-080140	ATRE-080140
800	1400	500	ATTF-080050	ATPO-080140	ATPX-080140	ATRE-080140
800	1600	400	ATTF-080040	ATPO-080160	ATPX-080160	ATRE-080160
800	1600	500	ATTF-080050	ATPO-080160	ATPX-080160	ATRE-080160
800	1600	600	ATTF-080060	ATPO-080160	ATPX-080160	ATRE-080160
800	1800	400	ATTF-080040	ATPO-080180	ATPX-080180	ATRE-080180
800	1800	500	ATTF-080050	ATPO-080180	ATPX-080180	ATRE-080180
800	1800	600	ATTF-080060	ATPO-080180	ATPX-080180	ATRE-080180
800	1800	800	ATTF-080080	ATPO-080180	ATPX-080180	ATRE-080180
800	2000	400	ATTF-080040	ATPO-080200	ATPX-080200	ATRE-080200
800	2000	500	ATTF-080050	ATPO-080200	ATPX-080200	ATRE-080200
800	2000	600	ATTF-080060	ATPO-080200	ATPX-080200	ATRE-080200
800	2000	800	ATTF-080080	ATPO-080200	ATPX-080200	ATRE-080200
800	2200	500	ATTF-080050	ATPO-080220	ATPX-080220	ATRE-080220
800	2200	600	ATTF-080060	ATPO-080220	ATPX-080220	ATRE-080220
800	2200	800	ATTF-080080	ATPO-080220	ATPX-080220	ATRE-080220



characteristics

• STRUCTURE

Profile and rails are made up of a unique closed profile manufactured from 1.5mm sheet steel, fully welded and with rounded edges. The frame corners are manufactured with orthogonal joints laser welded to vertical upright rails and horizontal rails for the roof and bottom. Only 8 high resistance screws are necessary to mount the structure, while two position pins allow the easy mounting of the two parts of the joint.

paint finish

CE-TEK standard epoxy polyester powder coating.
Structure, door and rear panel RAL 7032 textured finish.
Roof and bottom RAL 7025 textured finish.

assembled cabinet (PR)

Supply includes:

- structure
- door manufactured from 2mm sheet steel with stiffening frame, complete with Ø 3mm double bar locking system
- rear panel manufactured from 1.5mm sheet steel
- removable roof manufactured from 1.5mm sheet steel
- bottom with adjustable cable entry manufactured from 1.5mm sheet steel.

flat-pack cabinet

Supply includes:

- composition to be assembled complying with customers requests
- panels and doors are supplied together with two vertical uprights complete with accessories.

conformity and approval



conformity and approval assembled cabinet



conformity and approval flat-pack cabinet



protection degree

- IP 55 complying with EN50298; EN60529
- type 12 complying with UL508A; UL50
- impact resistance IK10 complying with EN500298; EN50102.

To be ordered separately eyebolts and/or lifting brackets: see 'complementary accessories'.

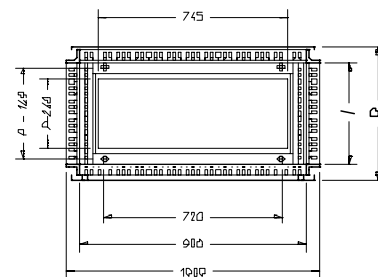
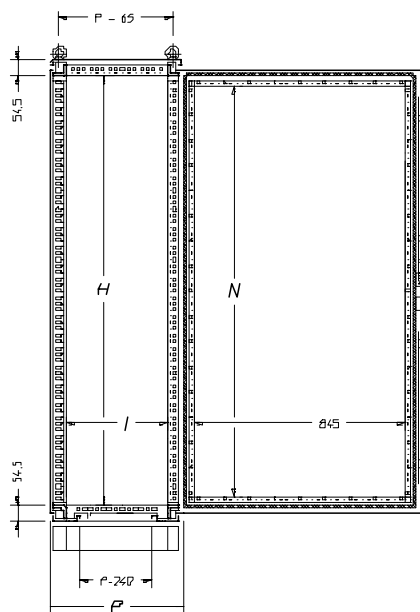
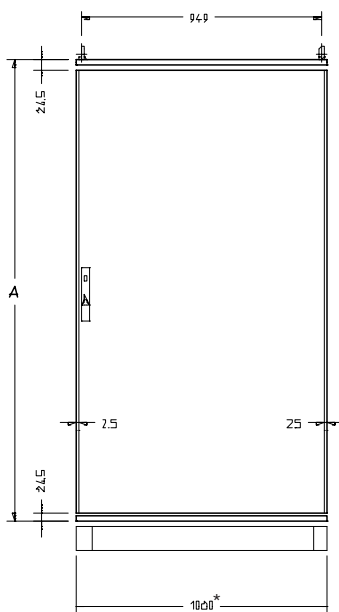

* With side panels mounted L = 1016 mm

code		cabinet dim.		usable internal area			
mod.	art.	A	P	H	I	N	
CE1000	101604PR	1609	414	1500	300	1430	
	101605PR		514		400		
	101606PR		614		500		
	101804PR	1809	414	1700	300	1630	
	101805PR		514		400		
	101806PR		614		500		
	101808PR	2009	814	1900	700	1830	
	102004PR		414		300		
	102005PR		514		400		
	102006PR	2209	614	2100	500	2030	
	102205PR		814		700		
	102206PR		514		400		
	102208PR			814		700	

assembled cabinet

cabinet dimensions			blank door + rear panel	glazed door + rear panel	front + rear blank doors
width	height	depth			
1000	1600	400	CE1000-101604PR	CE1000-101604PX	CE1000-101604DP
1000	1600	500	CE1000-101605PR	CE1000-101605PX	CE1000-101605DP
1000	1600	600	CE1000-101606PR	CE1000-101606PX	CE1000-101606DP
1000	1800	400	CE1000-101804PR	CE1000-101804PX	CE1000-101804DP
1000	1800	500	CE1000-101805PR	CE1000-101805PX	CE1000-101805DP
1000	1800	600	CE1000-101806PR	CE1000-101806PX	CE1000-101806DP
1000	1800	800	CE1000-101808PR	CE1000-101808PX	CE1000-101808DP
1000	2000	400	CE1000-102004PR	CE1000-102004PX	CE1000-102004DP
1000	2000	500	CE1000-102005PR	CE1000-102005PX	CE1000-102005DP
1000	2000	600	CE1000-102006PR	CE1000-102006PX	CE1000-102006DP
1000	2000	800	CE1000-102008PR	CE1000-102008PX	CE1000-102008DP
1000	2200	500	CE1000-102205PR	CE1000-102205PX	CE1000-102205DP
1000	2200	600	CE1000-102206PR	CE1000-102206PX	CE1000-102206DP
1000	2200	800	CE1000-102208PR	CE1000-102208PX	CE1000-102208DP

flat-pack cabinet

cabinet dimensions			roof + bottom	blank door	doors 500+500	glazed door	rear panel
width	height	depth					
1000	1600	400	ATTF-100040	ATPO-100160	ATPO-100160DP	ATPX-100160	ATRE-100160
1000	1600	500	ATTF-100050	ATPO-100160	ATPO-100160DP	ATPX-100160	ATRE-100160
1000	1600	600	ATTF-100060	ATPO-100160	ATPO-100160DP	ATPX-100160	ATRE-100160
1000	1800	400	ATTF-100040	ATPO-100180	ATPO-100180DP	ATPX-100180	ATRE-100180
1000	1800	500	ATTF-100050	ATPO-100180	ATPO-100180DP	ATPX-100180	ATRE-100180
1000	1800	600	ATTF-100060	ATPO-100180	ATPO-100180DP	ATPX-100180	ATRE-100180
1000	1800	800	ATTF-100080	ATPO-100180	ATPO-100180DP	ATPX-100180	ATRE-100180
1000	2000	400	ATTF-100040	ATPO-100200	ATPO-100200DP	ATPX-100200	ATRE-100200
1000	2000	500	ATTF-100050	ATPO-100200	ATPO-100200DP	ATPX-100200	ATRE-100200
1000	2000	600	ATTF-100060	ATPO-100200	ATPO-100200DP	ATPX-100200	ATRE-100200
1000	2000	800	ATTF-100080	ATPO-100200	ATPO-100200DP	ATPX-100200	ATRE-100200
1000	2200	500	ATTF-100050	ATPO-100220	ATPO-100220DP	ATPX-100220	ATRE-100220
1000	2200	600	ATTF-100060	ATPO-100220	ATPO-100220DP	ATPX-100220	ATRE-100220
1000	2200	800	ATTF-100080	ATPO-100220	ATPO-100220DP	ATPX-100220	ATRE-100220

Remark: for cabinets supplied flat-pack with doors 500+500, WTAP-001 mechanical latches have to be ordered separately.



characteristics

• STRUCTURE

Profile and rails are made up of a unique closed profile manufactured from 1.5mm sheet steel, fully welded and with rounded edges. The frame corners are manufactured with orthogonal joints laser welded to vertical upright rails and horizontal rails for the roof and bottom. Only 8 high resistance screws are necessary to mount the structure, while two position pins allow the easy mounting of the two parts of the joint.

paint finish

CE-TEK standard epoxy polyester powder coating.
Structure, door and rear panel RAL 7032 textured finish.
Roof and bottom RAL 7025 textured finish.

assembled cabinet (PR)

Supply includes:

- structure
- door manufactured from 2mm sheet steel with stiffening frame, complete with Ø 3mm double bar locking system
- rear panel manufactured from 1.5mm sheet steel
- removable roof manufactured from 1.5mm sheet steel
- bottom with adjustable cable entry manufactured from 1.5mm sheet steel.

flat-pack cabinet

Supply includes:

- composition to be assembled complying with customers requests
- panels and doors are supplied together with two vertical uprights complete with accessories.

conformity and approval



conformity and approval assembled cabinet



conformity and approval flat-pack cabinet



protection degree

- IP 55 complying with EN50298; EN60529
- type 12 complying with UL508A; UL50
- impact resistance IK10 complying with EN500298; EN50102.

To be ordered separately eyebolts and/or lifting brackets: see 'complementary accessories'.

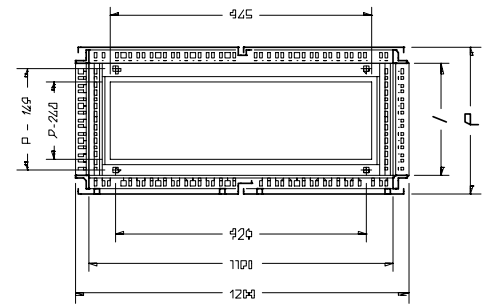
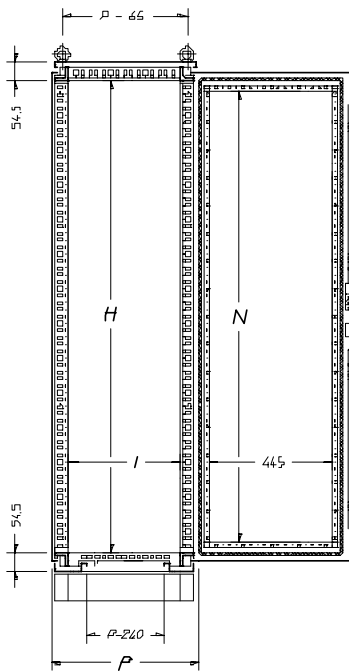
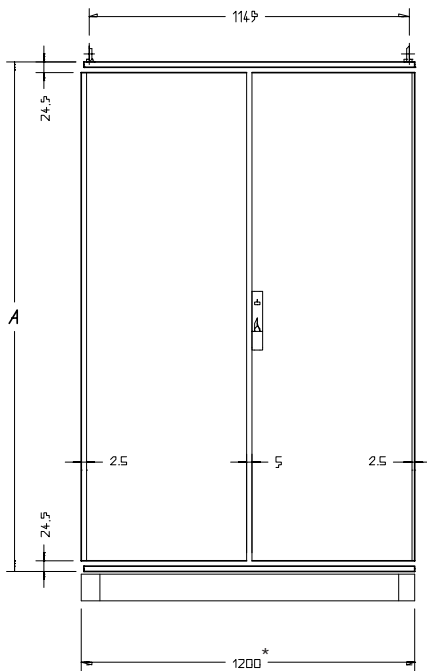

* With side panels mounted L = 1216 mm

code		cabinet dim.		usable internal area		
mod.	art.	A	P	H	I	N
CE1000	121404PR	1409	414	1300	300	1230
	121405PR		514		400	
	121604PR	1609	414	1500	300	1430
	121605PR		514		400	
	121606PR	1809	614	1700	500	1630
	121804PR		414		300	
	121805PR	1809	514	1700	400	1630
	121806PR		614		500	
	121808PR	2009	814	1900	700	1830
	122004PR		414		300	
	122005PR	2009	514	1900	400	1830
	122006PR		614		500	
	122008PR	2209	814	2100	700	2030
	122205PR		514		400	
122206PR	2209	614	2100	500	2030	
122208PR		814		700		

assembled cabinet

cabinet dimensions			blank door + rear panel	front + rear doors
width	height	depth		
1200	1400	400	CE10000-121404PR	CE1000-121404DP
1200	1400	500	CE1000-121405PR	CE1000-121405DP
1200	1600	400	CE1000-121604PR	CE1000-121604DP
1200	1600	500	CE1000-121605PR	CE1000-121605DP
1200	1600	600	CE1000-121606PR	CE1000-121606DP
1200	1800	400	CE1000-121804PR	CE1000-121804DP
1200	1800	500	CE1000-121805PR	CE1000-121805DP
1200	1800	600	CE1000-121806PR	CE1000-121806DP
1200	1800	800	CE1000-121808PR	CE1000-121808DP
1200	2000	400	CE1000-122004PR	CE1000-122004DP
1200	2000	500	CE1000-122005PR	CE1000-122005DP
1200	2000	600	CE1000-122006PR	CE1000-122006DP
1200	2000	800	CE1000-122008PR	CE1000-122008DP
1200	2000	1000	CE1000-122010PR	---
1200	2200	500	CE1000-122205PR	CE1000-122205DP
				CE1000-122206DP
				CE1000-122208DP

flat-pack cabinet

cabinet dimensions			roof + bottom	doors 600+600	rear panel
width	height	depth			
1200	1400	400	ATTF-120040	ATPO-120140	ATRE-120140
1200	1400	500	ATTF-120050	ATPO-120140	ATRE-120140
1200	1600	400	ATTF-120040	ATPO-120160	ATRE-120160
1200	1600	500	ATTF-120050	ATPO-120160	ATRE-120160
1200	1600	600	ATTF-120060	ATPO-120160	ATRE-120160
1200	1800	400	ATTF-120040	ATPO-120180	ATRE-120180
1200	1800	500	ATTF-120050	ATPO-120180	ATRE-120180
1200	1800	600	ATTF-120060	ATPO-120180	ATRE-120180
1200	1800	800	ATTF-120080	ATPO-120180	ATRE-120180
1200	2000	400	ATTF-120040	ATPO-120200	ATRE-120200
1200	2000	500	ATTF-120050	ATPO-120200	ATRE-120200
1200	2000	600	ATTF-120060	ATPO-120200	ATRE-120200
1200	2000	800	ATTF-120080	ATPO-120200	ATRE-120200
1200	2200	500	ATTF-120050	ATPO-120220	ATRE-120220
1200	2200	600	ATTF-120060	ATPO-120220	ATRE-120220
1200	2200	800	ATTF-120080	ATPO-120220	ATRE-120220

Remark: for cabinets supplied flat-pack with rear door, WTAP-001 mechanical latches have to be ordered separately.



characteristics

• STRUCTURE

Profile and rails are made up of a unique closed profile manufactured from 1.5mm sheet steel, fully welded and with rounded edges. The frame corners are manufactured with orthogonal joints laser welded to vertical upright rails and horizontal rails for the roof and bottom. Only 8 high resistance screws are necessary to mount the structure, while two position pins allow the easy mounting of the two parts of the joint.

paint finish

CE-TEK standard epoxy polyester powder coating.
Structure, door and rear panel RAL 7032 textured finish.
Roof and bottom RAL 7025 textured finish.

assembled cabinet (PR)

Supply includes:

- structure
- door manufactured from 2mm sheet steel with stiffening frame, complete with Ø 3mm double bar locking system
- rear panel manufactured from 1.5mm sheet steel
- removable roof manufactured from 1.5mm sheet steel
- bottom with adjustable cable entry manufactured from 1.5mm sheet steel.

flat-pack cabinet

Supply includes:

- composition to be assembled complying with customers requests
- panels and doors are supplied together with two vertical uprights complete with accessories.

conformity and approval



conformity and approval assembled cabinet



conformity and approval flat-pack cabinet



protection degree

- IP 55 complying with EN50298; EN60529
- type 12 complying with UL508A; UL50
- impact resistance IK10 complying with EN500298; EN50102.

To be ordered separately eyebolts and/or lifting brackets: see 'complementary accessories'.

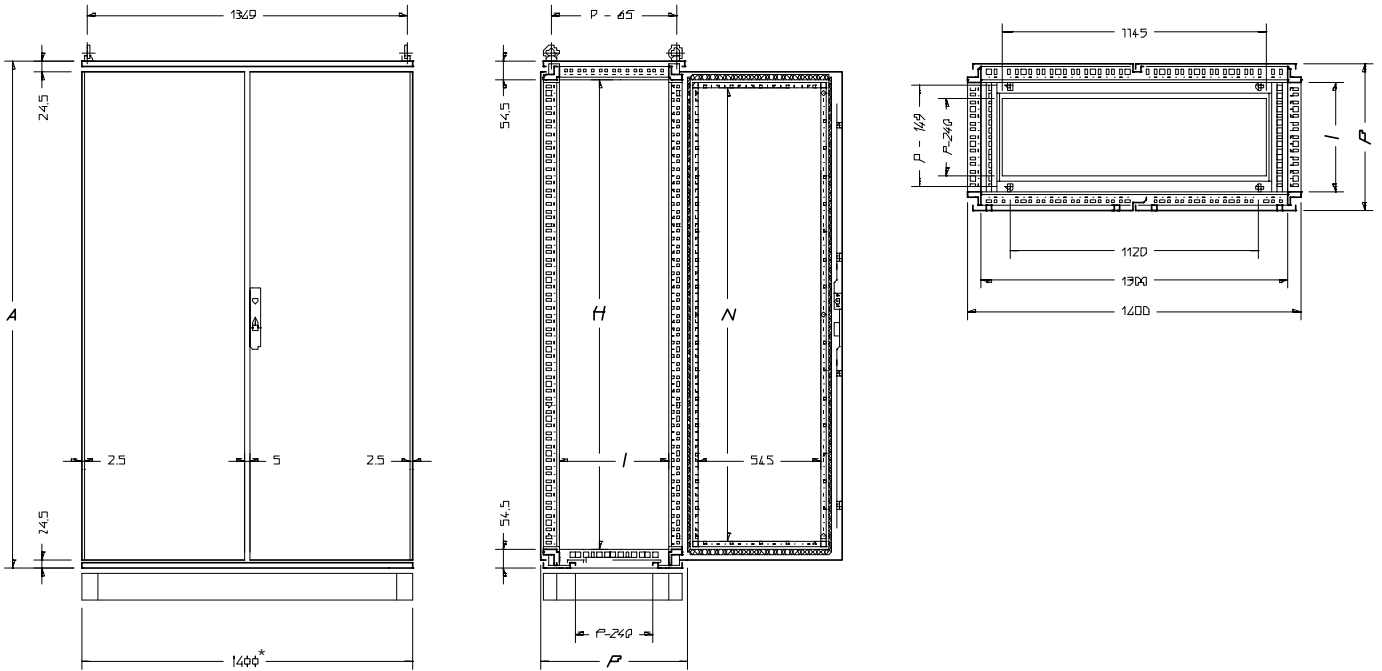

* With side panels mounted L = 1416 mm

code		cabinet dim.		usable internal area		
mod.	art.	A	P	H	I	N
CE1000	142004PR	2009	414	1900	300	1830
	142005PR		514		400	
	142006PR		614		500	
	142008PR		814		700	

assembled cabinet

cabinet dimensions			blank door + rear panel	front + rear doors
width	height	depth		
1400	2000	400	CE1000-142004PR	CE1000-142004DP
1400	2000	500	CE1000-142005PR	CE1000-142005DP
1400	2000	600	CE1000-142006PR	CE1000-142006DP
1400	2000	800	CE1000-142008PR	CE1000-142008DP

flat-pack cabinet

cabinet dimensions			roof + bottom	doors 700+700	rear panel
width	height	depth			
1400	2000	400	ATTF-140040	ATPO-140200	ATRE-140200
1400	2000	500	ATTF-140050	ATPO-140200	ATRE-140200
1400	2000	600	ATTF-140060	ATPO-140200	ATRE-140200
1400	2000	800	ATTF-140080	ATPO-140200	ATRE-140200

Remark: for cabinets supplied flat-pack with rear door, WTAP-001 mechanical latches have to be ordered separately.



characteristics

• STRUCTURE

Profile and rails are made up of a unique closed profile manufactured from 1.5mm sheet steel, fully welded and with rounded edges. The frame corners are manufactured with orthogonal joints laser welded to vertical upright rails and horizontal rails for the roof and bottom. Only 8 high resistance screws are necessary to mount the structure, while two position pins allow the easy mounting of the two parts of the joint.

paint finish

CE-TEK standard epoxy polyester powder coating.
Structure, door and rear panel RAL 7032 textured finish.
Roof and bottom RAL 7025 textured finish.

assembled cabinet (PR)

Supply includes:

- structure
- door manufactured from 2mm sheet steel with stiffening frame, complete with Ø 3mm double bar locking system
- rear panel manufactured from 1.5mm sheet steel
- removable roof manufactured from 1.5mm sheet steel
- bottom with adjustable cable entry manufactured from 1.5mm sheet steel.

flat-pack cabinet

Supply includes:

- composition to be assembled complying with customers requests
- panels and doors are supplied together with two vertical uprights complete with accessories.

conformity and approval



conformity and approval assembled cabinet



conformity and approval flat-pack cabinet



protection degree

- IP 55 complying with EN50298; EN60529
- type 12 complying with UL508A; UL50
- impact resistance IK10 complying with EN500298; EN50102.

To be ordered separately eyebolts and/or lifting brackets: see 'complementary accessories'.

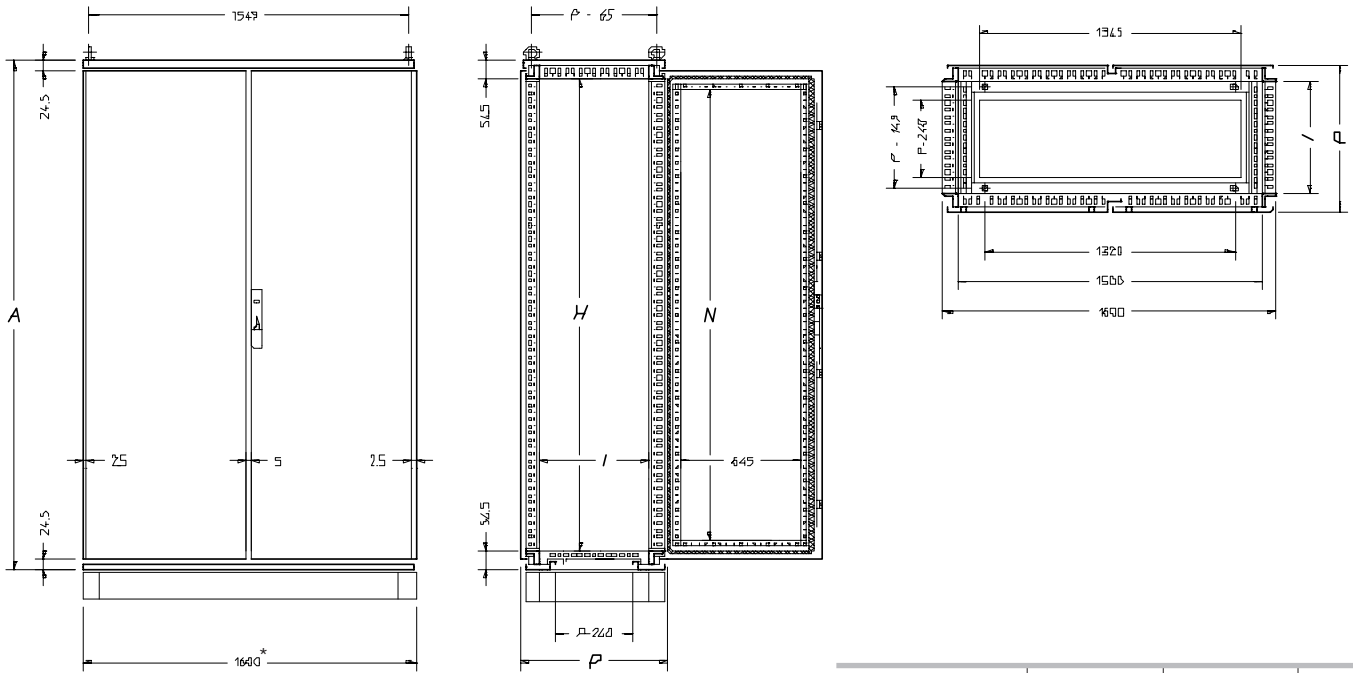

* With side panels mounted L = 1616 mm

code		cabinet dim.		usable internal area		
mod.	art.	A	P	H	I	N
CE1000	161404PR	1409	414	1300	300	1230
	161405PR		514		400	
	162004PR	414	1900		300	
	162005PR	514			400	
	162006PR	614			500	
	162008PR	814			700	

assembled cabinet

cabinet dimensions			blank door + rear panel	front + rear doors
width	height	depth		
1600	1400	400	CE1000-161404PR	CE1000-161404DP
1600	1400	500	CE1000-161405PR	CE1000-161405DP
1600	2000	400	CE1000-162004PR	CE1000-162004DP
1600	2000	500	CE1000-162005PR	CE1000-162005DP
1600	2000	600	CE1000-162006PR	CE1000-162006DP
1600	2000	800	CE1000-162008PR	CE1000-162008DP

flat-pack cabinet

cabinet dimensions			roof + bottom	doors 800+800	rear panel
width	height	depth			
1600	1400	400	ATTF-160040	ATPO-160140	ATRE-160140
1600	1400	500	ATTF-160050	ATPO-160140	ATRE-160140
1600	2000	400	ATTF-160040	ATPO-160200	ATRE-160200
1600	2000	500	ATTF-160050	ATPO-160200	ATRE-160200
1600	2000	600	ATTF-160060	ATPO-160200	ATRE-160200
1600	2000	800	ATTF-160080	ATPO-160200	ATRE-160200

Remark: for cabinets supplied flat-pack with rear door, WTAP-001 mechanical latches have to be ordered separately.